



NSW22009



N/14877



(39") 990±30

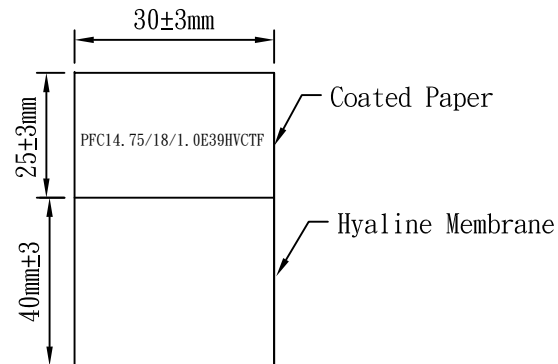
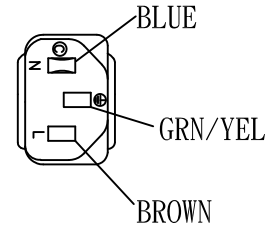
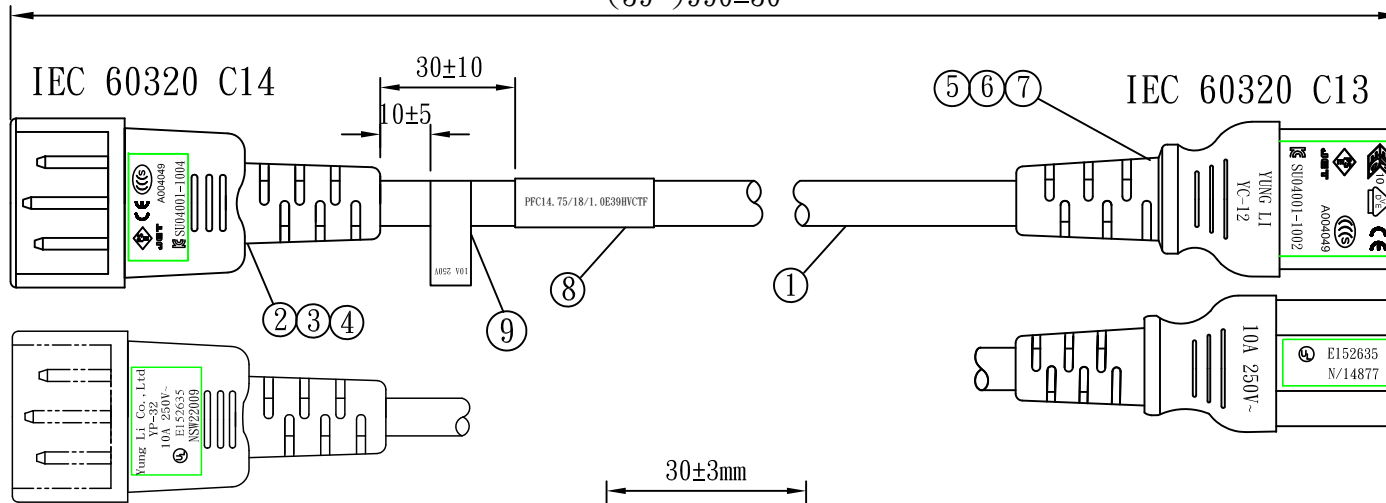
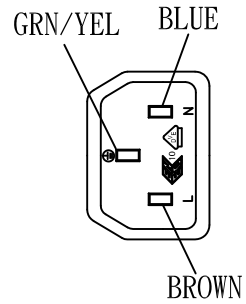

Packing:
1. Bulk Pack.
2. Bundles of 10 Pieces.

Wire Marking:

Yung Li Co., Ltd. H05VV-F 3G 0.75mm² <VDE> CE ES0140750 SU01027-4002

CCC A004049 60227 IEC 53(RVV) 300/500V c(UL)us E241374 SJT 3/C 18AWG(0.824mm²) 105°C
300V VW-1 <PS>E JET HVCTF 3X1.0mm² タイネツ -F-

NO.	SPECIFICATION	QTY	REMARK
1	0.75mm ² H05VV-F+18/3C SJT+1.0mm ² HVCTF BLACK	1PC	
2	YP-32 PVC PLASTIC:50P BLACK	15g/PC	
3	TER:98672BS-1	3PCS	
4	INNER BODY: 2X4	1PC	
5	TER:97740	3PCS	
6	YC-12 INNER BODY	1PC	
7	YC-12 PVC PLASTIC:50P BLACK	18g/PC	
8	LABEL: (40+25)*30mm	1PC	
9	LABEL: 55*15mm	1PC	

Tolerance >0±0.30 >1.0±0.50 >10.0±1.0 >20.0±2.0 Angle: ±1°	Approved		Date		StayOnline®			
	Checked		Date					
	Drawn	JAMIE	Date	15.06.17	Customer			
	Cat. No.	YP-32/YC-12			P/N.	PFC14.75/18/1.0E39HVCTF		
	Drawing No.	6627		Rev.	B	Material	P.V.C	Unit
					Scale			