

Twist-Lock® Devices
 50A, 3 Phase 480V AC, 3 Pole, 4 Wire
 Grounding
 Insulgrip® Connector

HUBBELL

Features

- Box terminal with hex socket threaded slug, permits high clamping pressure on conductors without damaging strands
- Heavy duty two-piece external cord clamp provides maximum strain relief
- Box terminal with hex socket threaded slug, permits high clamping pressure on conductors without damaging strands
- Thermoplastic polyester interior provides heat resistance and impact strength
- Oversized contacts minimize operating temperature

Ordering Information

Description	Cord Diameter	UPC	Catalog Number
Nylon cover, thermoplastic polyester interior	.830"-1.250" (21.08-31.75)	783585828428	CS8164C

Listings

Listed to UL 498
 Certified to CSA C22.2 No.42

Specifications

Housing	Nylon
Terminal Retainer	Thermoplastic polyester
Contacts	Brass
Terminal Screws	Stainless Steel
Cord Grip	Polyester

Performance

Electrical

Current Interrupting	Certified for current interrupting at full rated current
Dielectric Voltage	Withstands 2,000V minimum

Mechanical

Terminal Accommodation	#10 AWG - #6 AWG stranded copper wire only
------------------------	--

Environmental

Flammability	HB or better
Operating Temperatures	Maximum continuous 75°C; minimum -40°C (w/o impact)

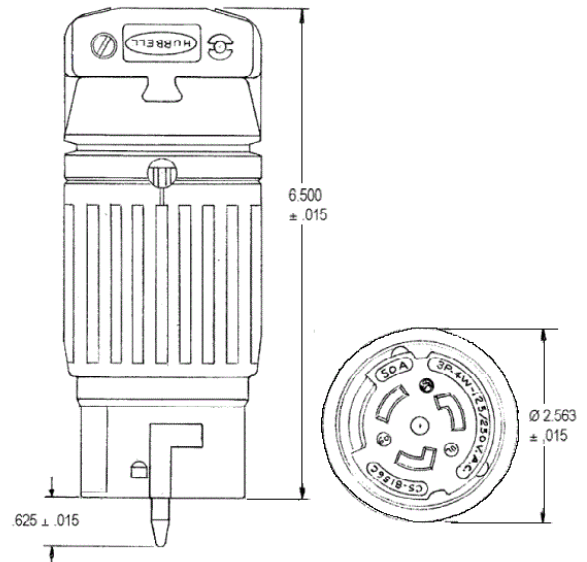

Accessories

Plug	CS8365C
Weatherproof Boot	HBL7717C
Flanged Inlet	CS8375
Weatherproof Boot	HBL7716C

Resources

Customer Use Drawing
 eCatalog

Dimensions in Inches (mm)

Hubbell Wiring Device-Kellems • Hubbell Incorporated (Delaware) • 40 Waterview Drive • Shelton, CT 06484

Phone (800) 288-6000 • Fax (800) 255-1031 • Specifications subject to change without notice.

