

Twist-Lock® Devices
 20A, 125V AC; 2 Pole, 3 Wire Grounding
 Valise® Connector

HUBBELL

Features

- Unique patented clamp type terminals provide a superior electrical connection by “bundling” the conductor strands when clamps are tightened
- Totally insulated impact and crush resistant nylon body
- Powerful cord grip prevents conductor slippage and strain on wiring terminals



Ordering Information

Description	Cord Diameter	UPC	Catalog Number
Black nylon.	.325" - .720" (8.26-18.3)	783585043067	HBL2323VBK

Listings

Listed to UL 498
 Fed.Spec. W-C-596
 Certified to CSA C22.2 No.42

Specifications

Housing	Black nylon
Contacts	Brass
Terminal Screws	#8 - 32 Steel (Philips / Slotted / Robertson)
Terminal Clamps	Steel - Nickel plated
Clamp Screws	#8 - 32 Steel - Zinc plated (Philips / Slotted / Robertson)

Performance

Electrical	
Current Interrupting	Certified for full rated current
Dielectric Voltage	Withstands 2,000V minimum
Mechanical	
Terminal Accommodation	#14 AWG- #8 AWG stranded copper wire only.
Terminal Identification	Terminals identified in accordance with UL 498
Environmental	
Flammability	HB or better per UL 94 or CSA 22.2 No. 0.6
Moisture Resistance	IP20 Suitability
Operating Temperature	Maximum continuous 75°C, minimum -40°C (w/o impact)

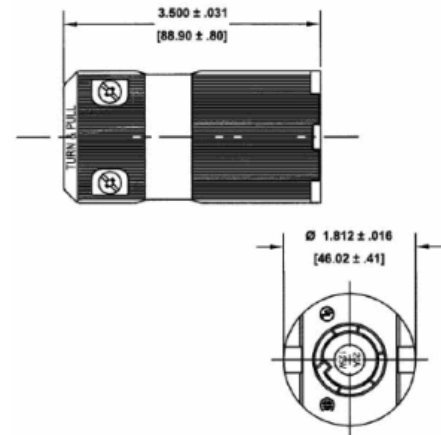

Accessories

Plug	HBL2323VBK
Plug	HBL2321VBK
Flanged Inlet	HBL2326
Weatherproof Boot	HBL60CM32V

Resources

Customer Use Drawing
 eCatalog

Dimensions in Inches (mm)

Hubbell Wiring Device-Kellems • Hubbell Incorporated (Delaware) • 40 Waterview Drive • Shelton, CT 06484

Phone (800) 288-6000 • Fax (800) 255-1031 • Specifications subject to change without notice.

