

Twist-Lock® Devices
 30A, 125V AC, 2 Pole, 3 Wire Grounding
 Corrosion Resistant Insulgrip® Connector

HUBBELL

Features

- Ribbed nylon housing provides a secure grip and impact and chemical resistance.
- Superior cord grip design protects terminations from excess strain.
- Integral dust shield protects wiring chamber from dust or contaminants.

Ordering Information

Description	Cord Diameter	UPC	Catalog Number
Corrosion resistant, yellow nylon.	.360"-.930" (9-24)	783585039091	HBL26CM13

Listings

Listed to UL 498
 Fed.Spec. W-C-596
 Certified to CSA C22.2 No.42

Specifications

Housing / Cord Clamp	Nylon
Terminal Retainer	Clear polycarbonate
Contacts	Nickel Plated Brass
Terminal Screws	#10-32 Bronze (Phillips / Slotted / Robertson)
Terminal Clamp	Cold rolled steel – nickel plated
Assembly Screws	Steel - nickel plated

Performance

Electrical

Current Interrupting	Certified for current interrupting at full rated current
Dielectric Voltage	Withstands 2,000V minimum

Mechanical

Terminal Accommodation	#16 AWG - #8 AWG stranded copper wire only.
Terminal Identification	Terminals identified in accordance with UL 498

Environmental

Flammability	HB or better per UL94 or CSA 22.2 No. 0.6
Moisture Resistance	IP20 Suitability
Operating Temperatures	Maximum Continuous 75°C Minimum -40°C (w/o impact)

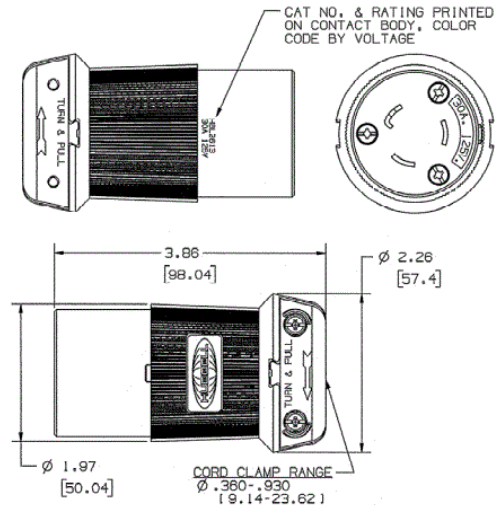

Accessories

Plug	HBL26CM11
Weatherproof Boot	HBL60CM32
Flanged Inlet	HBL2615
Weatherproof Boot	HBL60CM31

Resources

Customer Use Drawing
 eCatalog

Dimensions in Inches (mm)

Hubbell Wiring Device-Kellems • Hubbell Incorporated (Delaware) • 40 Waterview Drive • Shelton, CT 06484

Phone (800) 288-6000 • Fax (800) 255-1031 • Specifications subject to change without notice.

