

Straight Blade Devices
30A, 250V, 2 Pole, 3 Wire Grounding
Plug

HUBBELL



Ordering Information

Description	Cord Diameter	UPC	Catalog Number
Plug, nylon, angle, 4-position	.625"-1.187" (15.9-30.1)	783585015248	HBL9331



Specifications

Housing	Supertough Nylon
Blade Holder	Reinforced Thermoplastic Polyester
Terminal Retainer	Reinforced Thermoplastic Polyester
Cord Clamp	Reinforced Thermoplastic Polyester
Box Terminals	Brass

Performance

Electrical	
Current Interrupting	Certified for current interrupting at full rated current
Dielectric Voltage	Withstands 2,000V minimum
Mechanical	
Product Identification	Ratings are a permanent part of the device
Terminal Accommodation	#12-#4 AWG copper stranded or solid conductor only
Terminal Identification	Terminals identified in accordance with UL 498 and CSA
Environmental	
Flammability	UL 94 V-2
IP Suitability	IP20
Operating Temperatures	Maximum continuous 75°C; minimum -40°C (w/o impact)

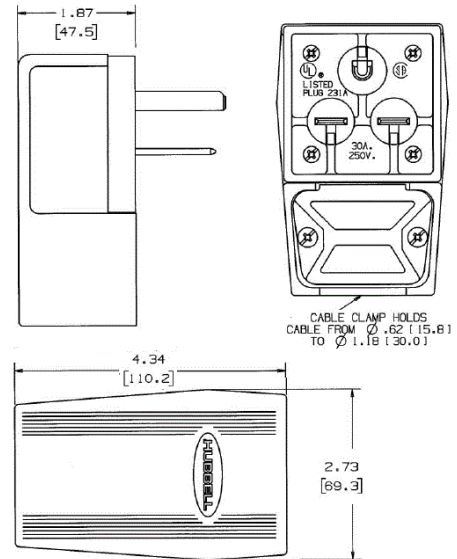

Resources

Customer Use Drawing
eCatalog

Dimensions in Inches (mm)

Hubbell Wiring Device-Kellems • Hubbell Incorporated (Delaware) • 40 Waterview Drive • Shelton, CT 06484

Phone (800) 288-6000 • Fax (800) 255-1031 • Specifications subject to change without notice.

